

Software Installation Instructions

Revision History

Version	Date	Changes
1.0	2019/01/09	First Release
1.1	2020/10/27	Updated NDE Lock Commissioning instructions
1.2	2023/11/28	Update NDE Lock Commissioning Instructions Added LE Lock Factory Reset and Commissioning Instructions Fixed Links

Table Of Contents

Revision History	2
Introduction	4
ENGAGE Account Creation	4
ENGAGE Mobile App	5
Site Creation	6
Using the Web Application	6
Using the Mobile Application	8
Gateway Factory Default Reset	9
NDE Lock Factory Default Reset	10
LE Lock Factory Default Reset	11
Gateway Commissioning	12
NDE Lock Commissioning	15
Gateway - Lock Link	22

Introduction

This document works under the assumption that the Schlage NDE Locks, the Schlage GWE gateway and the Kisi Controller 1.1/2.0 are already installed, powered on and connected to each other. If not, please refer to and complete the following guides, in order:

- [Schlage NDE Wireless Locks Installation Instructions](#)
- [How to Install the Schlage NDE Lock Instruction Video](#)
- [Kisi Getting Started - Installation Guide](#)
- [Schlage GWE installation instructions](#)
- [Kisi Hardware Installation Instructions](#)

ENGAGE Account Creation

An account is required to use the ENGAGE cloud-based web and mobile tools (which you will need to connect the locks).

Create an ENGAGE account on the web at <https://portal.allegionengage.com/signup>.

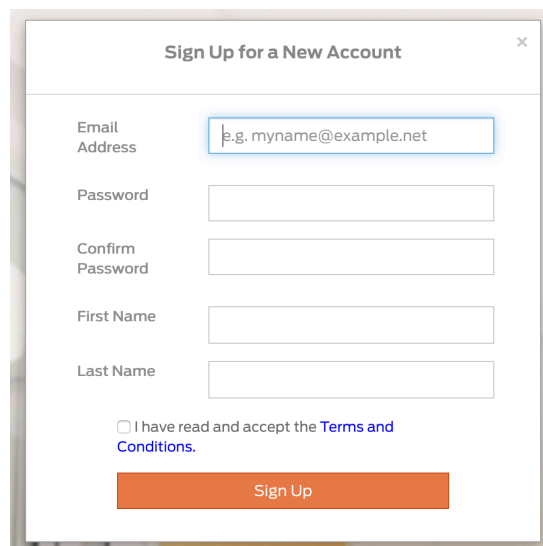

The image shows a web form titled "Sign Up for a New Account" with a close button (X) in the top right corner. The form contains the following fields and elements:

- Email Address:** A text input field with a placeholder "e.g. myname@example.net".
- Password:** A text input field.
- Confirm Password:** A text input field.
- First Name:** A text input field.
- Last Name:** A text input field.
- Terms and Conditions:** A checkbox followed by the text "I have read and accept the [Terms and Conditions](#)."
- Sign Up Button:** An orange button with the text "Sign Up".

Figure 2.1: ENGAGE account creation form

After creating a new account, you will receive a verification email. You must click on the link in the message to verify your account. This is required to activate your account.

Once you login to your account, you'll see a dashboard as the one in figure 2.2.

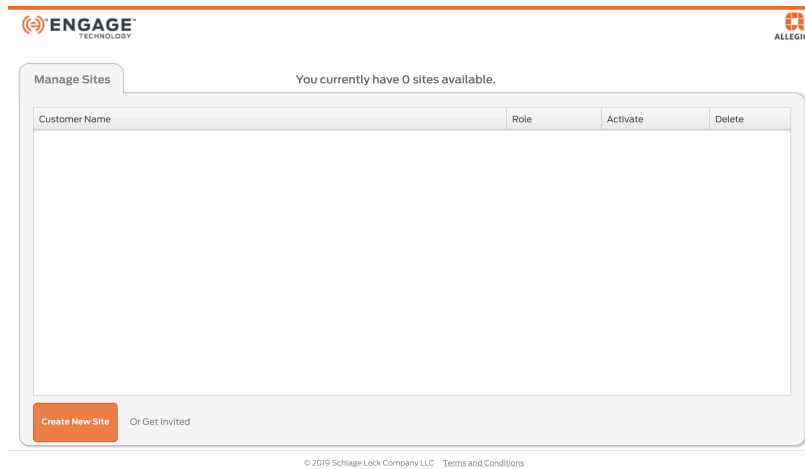

Figure 2.2: ENGAGE site dashboard

This dashboard shows all of the sites (locations) linked to the account.

ENGAGE Mobile App

The next step of this document will require the use of the Allegion ENGAGE mobile app. To download it, search for “Allegion ENGAGE” on the App store for iOS (Fig. 3.1) or Google play for Android users (Fig. 3.2) to download.

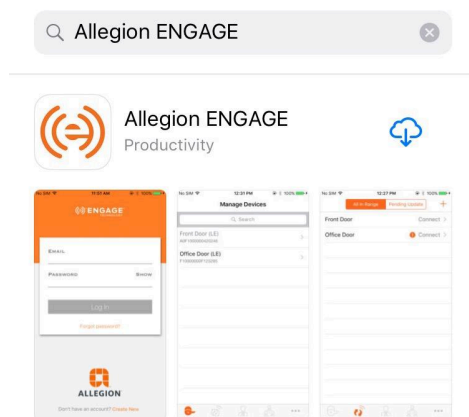

Figure 3.1: iOS App Store

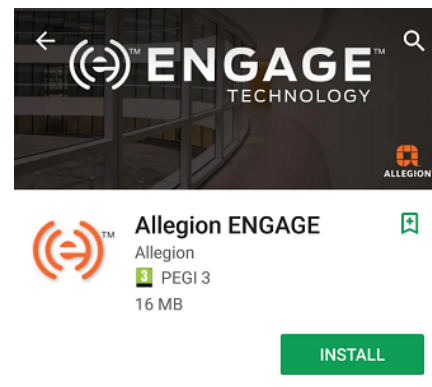

Figure 3.2: Google Play Store

After downloading and opening the app, you'll be shown a login page. Login to the account created in the previous step. This is required, as it will be our main platform for operating the locks hereafter.

After logging in, you'll see a screen like the one shown in Figure 3.4 with a message displayed. For the moment ignore the message by pressing OK (we'll be adding sites later). Afterwards, the screen should look like image 3.5.

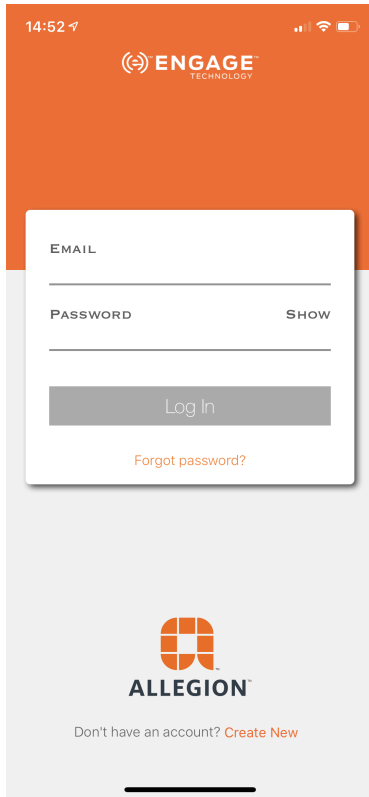

Figure 3.3: ENGAGE App login screen.

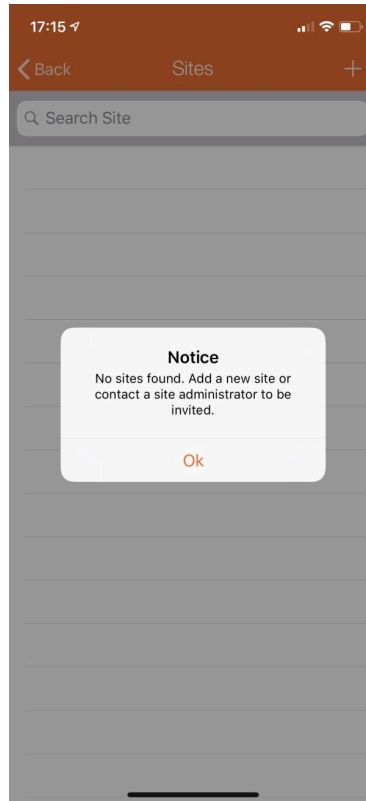

Figure 3.4: ENGAGE App message after login.

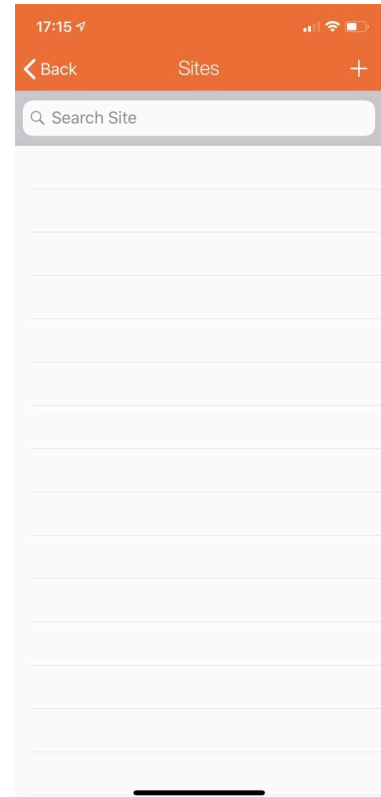

Figure 3.5: ENGAGE App after the login message.

WARNING: Do not create a new ENGAGE account from the ENGAGE mobile app. Navigate to <https://portal.allegionengage.com/signup> to set up your account, then sign into the app using the account you've already created.

Site Creation

Using the Web Application

Login to your account in <https://portal.allegionengage.com/signin>. After signing in you'll be redirected to the dashboard already shown in Figure 2.2. Press the "create new site" button. A form as the one in figure 4.2 should be shown.

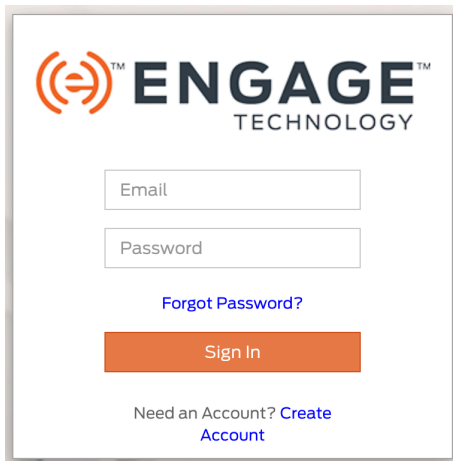

Figure 4.1: ENGAGE Web Login

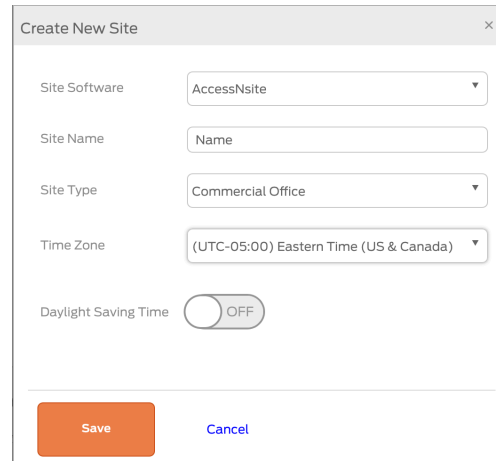

Figure 4.2: New site creation form

To create a site, complete the fields as follows:

- Site Software: choose any of them **with the exception of ENGAGE**.
- Site Name: choose a site name that represents the place where the locks are being installed. This will be important as you will use the name to assign it to a door in the Kisi interface, so you need to know where each lock is
- Site Type: pick the one that matches the type of space the better, this field is not relevant, so don't worry if none of them match exactly.
- Timezone: Pick the one that matches the location of the site.
- Daylight Saving Time: Enable or disable according to your needs.

After completing the form, press Save. Afterwards, you should be redirected to the ENGAGE dashboard. Now the newly created site should appear. In figure 4.3 we show the dashboard with a created test site.

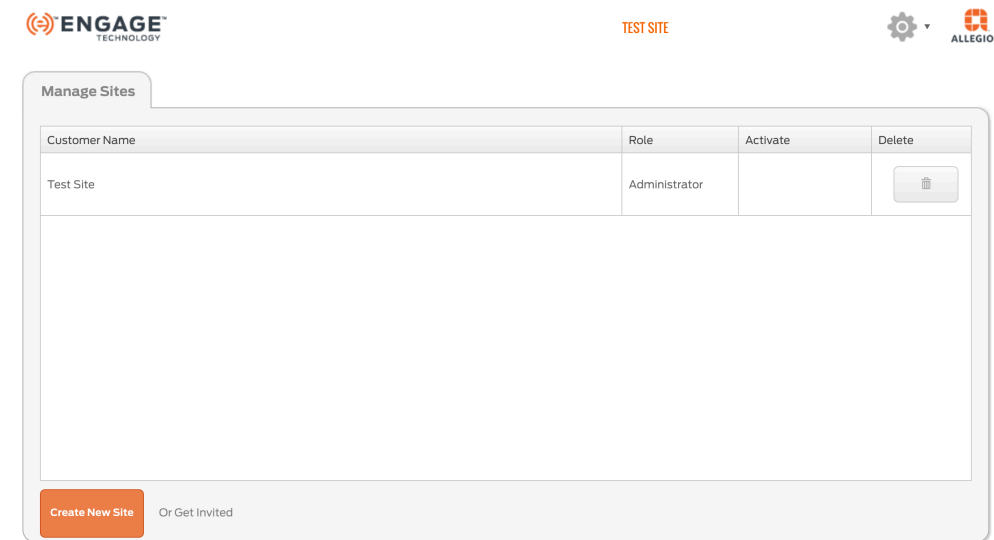

Figure 4.3: ENGAGE dashboard after site creation

Using the Mobile Application

Open the ENGAGE mobile app and login with the created account, as shown in figures 3.3, 3.4 and 3.5.

After this, press the plus button in the upper right corner of the site's screen, seen again in Figure 4.4. After that a new screen to select the Access Control Software is shown (Figure 4.5). The user can pick any **with the exception of ENGAGE**. After this, a new screen with a form is shown (Figure 4.6).

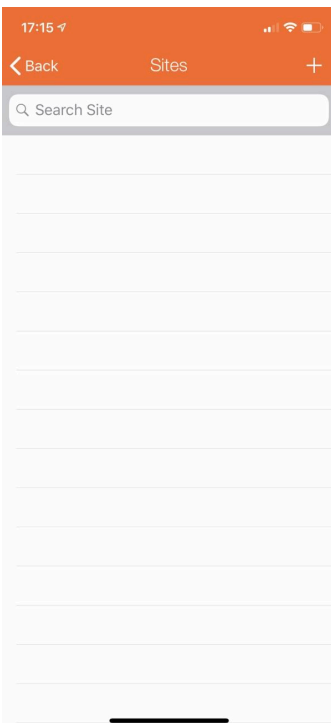

Figure 4.4: ENGAGE App Sites screen.

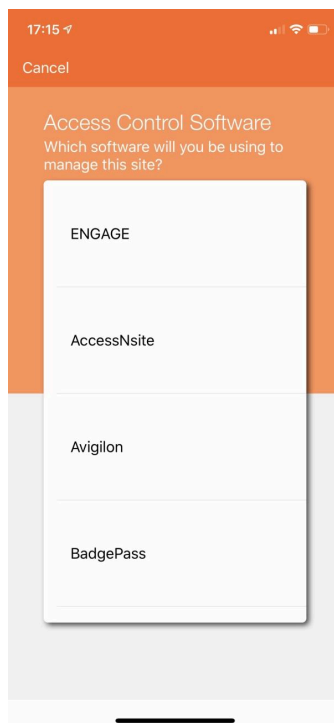

Figure 4.5: ENGAGE App Access Control Software selection.

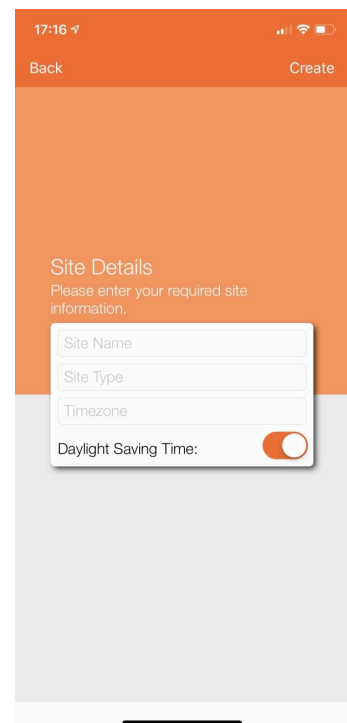

Figure 4.6: ENGAGE App site creation form.

To create a site, complete the fields as follows:

- Site Name: choose a site name that represents the place where the locks are being installed. This will be important as you will use the name to assign it to a door in the Kisi interface, so you need to know where each lock is
- Site Type: pick the one that matches the type of space the better, this field is not relevant, so don't worry if none of them match exactly.
- Timezone: Pick the one that matches the location of the site.
- Daylight Saving Time: Enable or disable according to your needs

After completing the form, press create. After this, the site's screen should show a newly created site. In figure 4.7 we show the site's screen with a created test site.

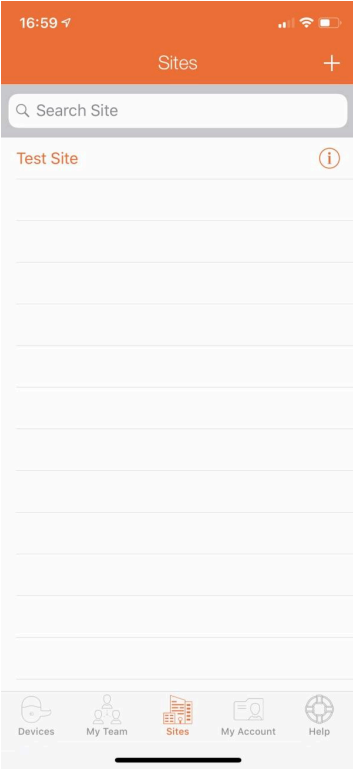

Figure 4.7: Engage sites screen after new site creation.

Gateway Factory Default Reset

Figure 4.1 shows the location of the Factory Default Reset (FDR) button.

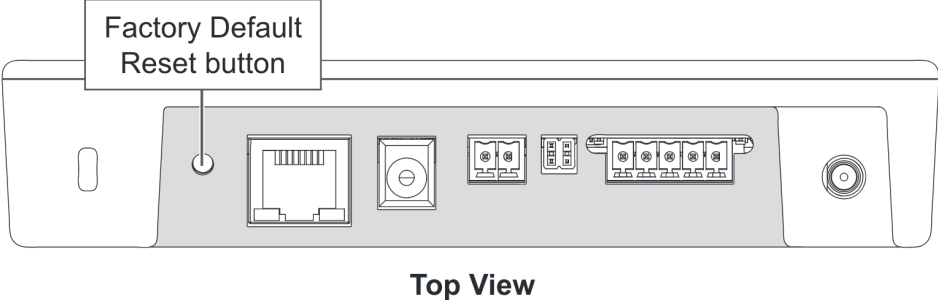

Figure 4.1: Schlage GWE Factory Default Reset Button

To perform a gateway factory reset do the following:

- Hold the button until the Gateway Status LED flashes green two times and remains solid. After the indicator flashes twice, you may release the FDR button.
- After starting the FDR process the Gateway indicator will be solid green for a moment and reboot. The reboot process can take a few minutes. During the boot process the Gateway indicator will be solid amber. The Gateway will be in a factory default state when the indicator is solid red.

NDE Lock Factory Default Reset

To perform a factory reset of a NDE lock, you need to remove the cover of the inside handle, as shown in Figure 5.1.

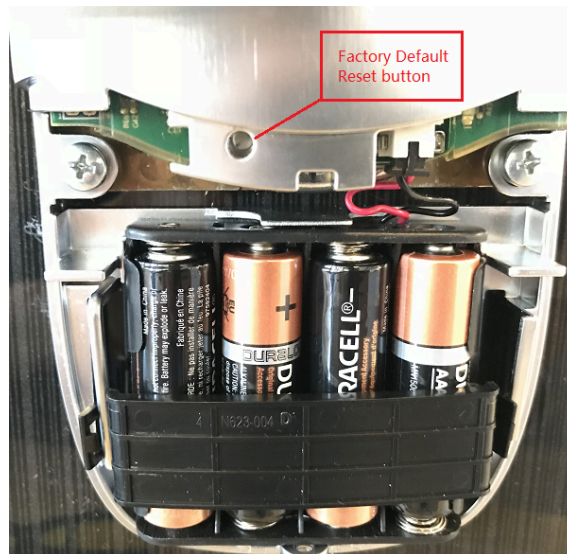

Figure 5.1: NDE lock without cover.

After removing the cover do the following:

- Press and hold the Factory Default Reset button for 5 seconds. After this the The NDE will blink green two times and beep two times.
- Turn the inside lever 3 times within 20 seconds - the LED will blink red and the lock will beep with each turn.
- You should hear one long beep after this process. **Once you hear it, close the cover again**

LE Lock Factory Default Reset

To perform a factory reset of a LE lock, you need to remove the cover of the inside handle, as shown in Figure 5.2.

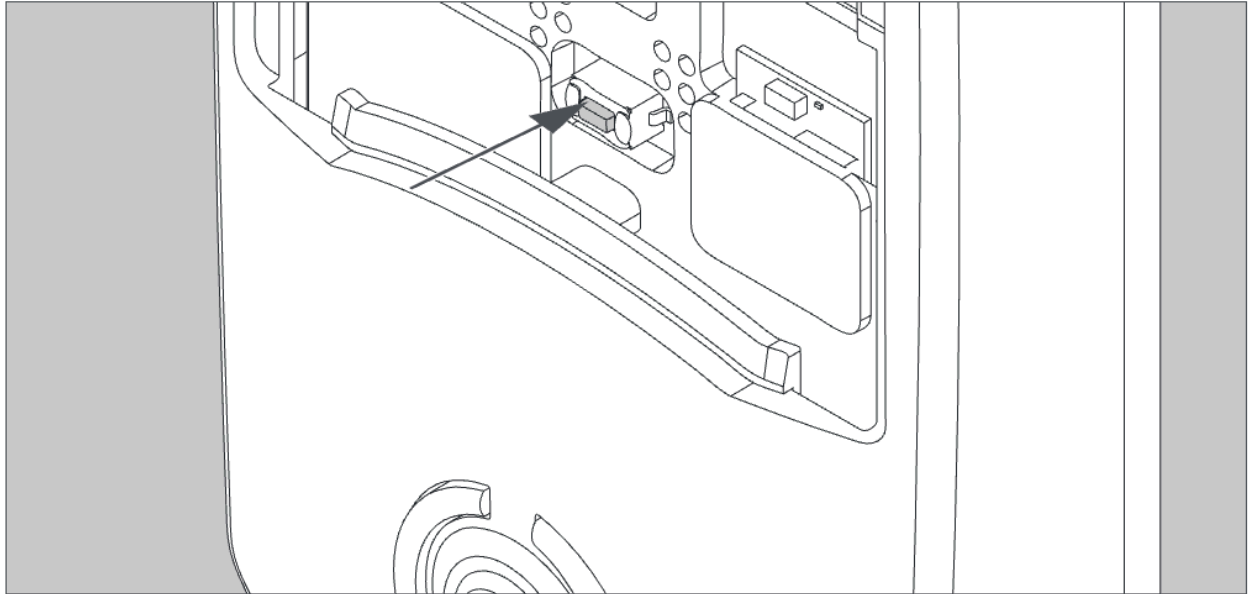

Figure 5.2: LE lock without cover.

After removing the cover do the following:

- Press and hold the Factory Default Reset button for 5 seconds. After this the The LE Lock will blink green two times and beep two times.
- Turn the inside lever 3 times within 20 seconds - the LED will blink red and the lock will beep with each turn.

You should hear one long beep after this process. **Once you hear it, close the cover again**

Gateway Commissioning

Before commissioning the gateway, be sure that the gateway is ready to be commissioned. If the LED light is solid red, you're good to go. The commissioning process is done using the ENGAGE mobile App and a Bluetooth connection, so Bluetooth needs to be enabled on the phone and you must be within the range of the gateway (generally within the same room). The commissioning process is unique to each gateway, so it'll have to be re-done for every new gateway added to a site.

To commission the gateway, do as follows:

- Go to the create places screen, and press on the created place (Figure 6.1).
- After this a screen called devices is shown (Figure 6.2). Press the plus (+) sign in the top right corner. This will show a new screen with different type of devices (Figure 6.3).
- Select the GWE Gateway. This will show a new screen where it will scan for nearby Gateways (Figure 6.4).
- If the gateway is shown, select it. If not, try moving closer to the gateway, and restart the process.
- Once the gateway is selected, please verify that the gateway light is blinking, as indicated in the Application (Figure 6.5). If it is, press Yes.
- After this, you'll be asked to select a name for the gateway. We recommend selecting a name that will differentiate it from other gateways that might be installed in the site (Figure 6.6) for ease of use.
- After naming the site you'll be shown a screen to select the Gateway communication mode. **You MUST select RSI** (Figure 6.7).
- After this, you'll be shown a screen to configure the Gateway. **The RS-485 Address MUST be set to zero (0), the Low door address to zero (0) and the high door address to fifteen (15).**(Figure 6.8).
- After this, you'll be shown a screen indicating the application is "preparing your device" (Figure 6.9).
- After the process is completed you'll be shown a screen indicating success with a green checkmark. Press the Finish button (Figure 6.10).
- Finally, you'll be redirected to the device's screen, and the gateway must be shown in the list of devices linked to that site (Figure 6.11).

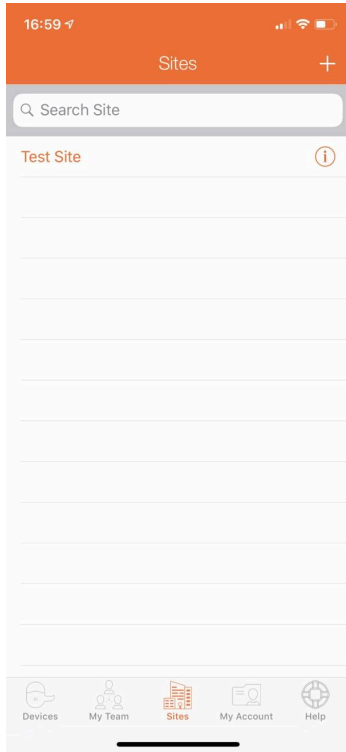

Figure 6.1

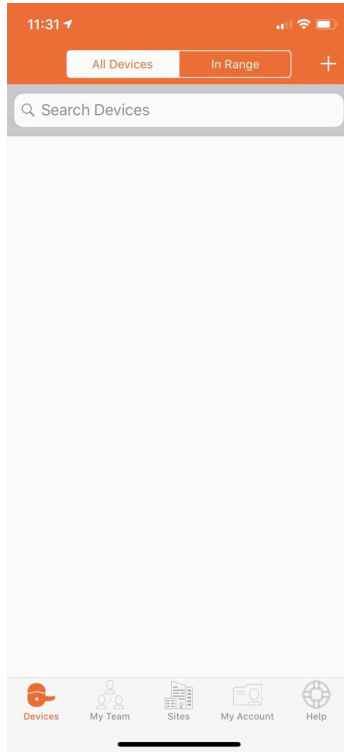

Figure 6.2

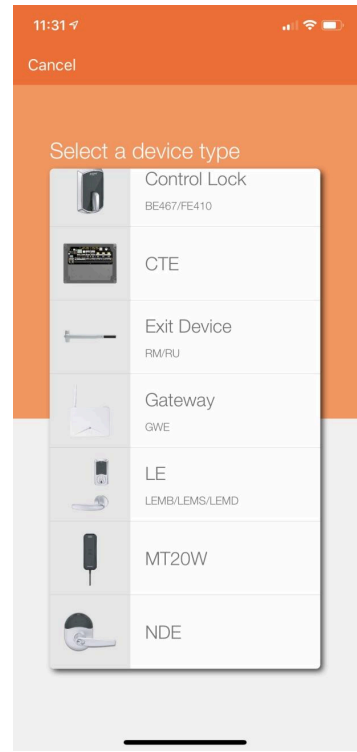

Figure 6.3

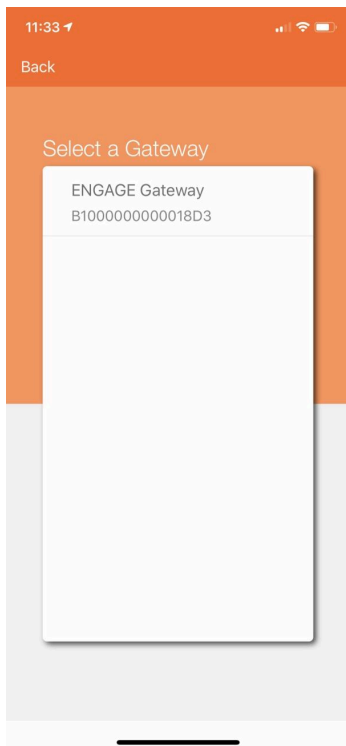

Figure 6.4

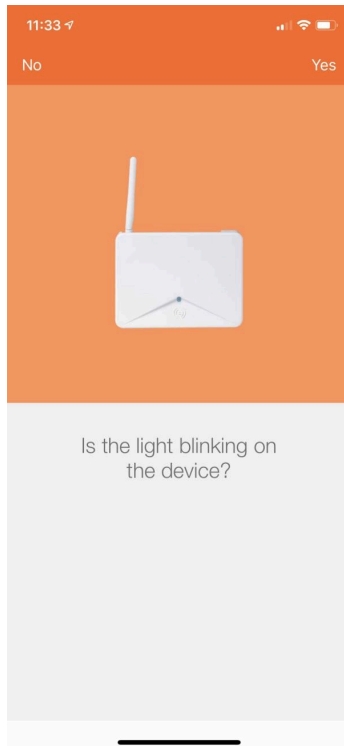

Figure 6.5

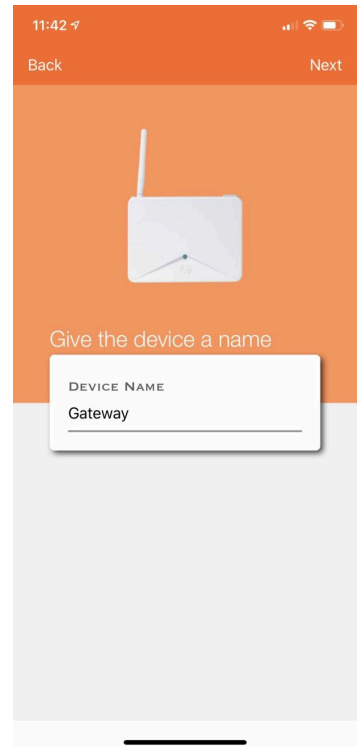

Figure 6.6

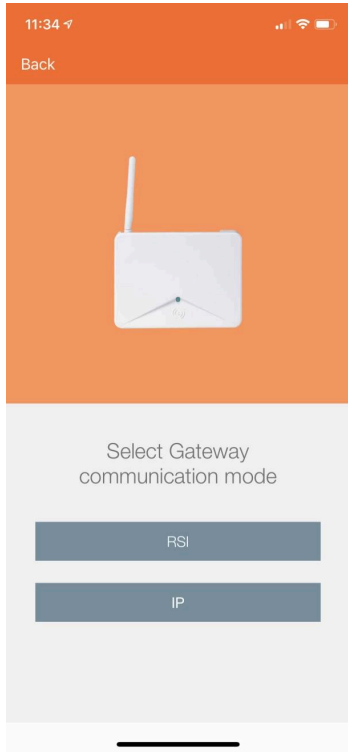

Figure 6.7

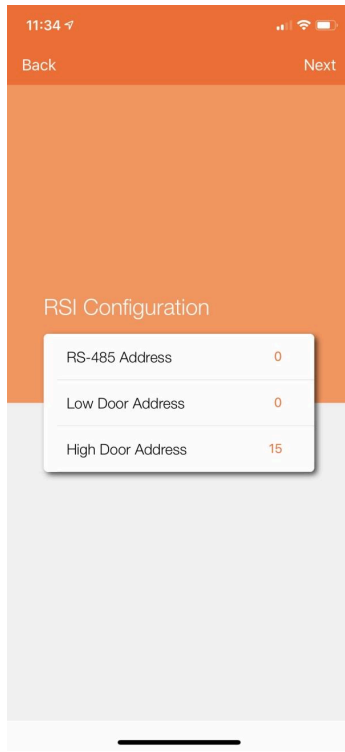

Figure 6.8

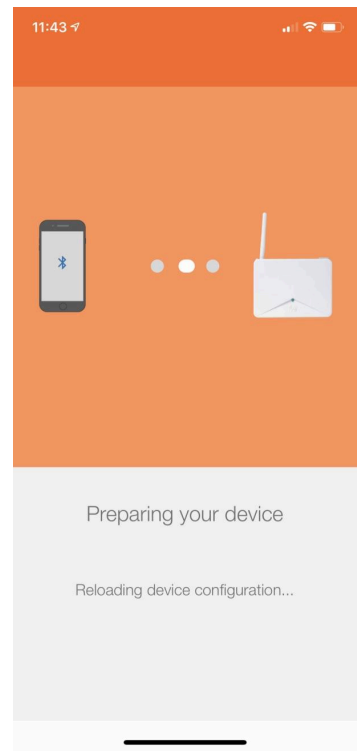

Figure 6.9

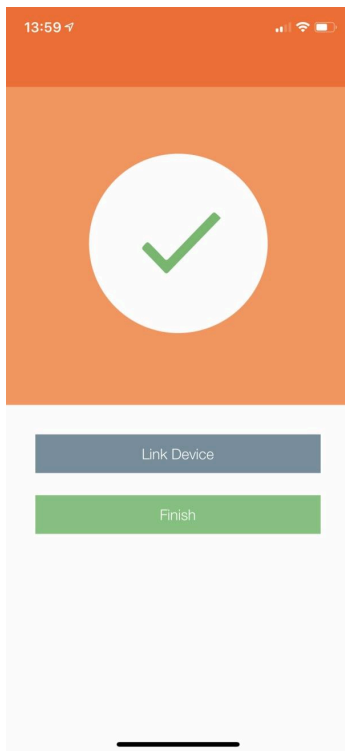

Figure 6.10

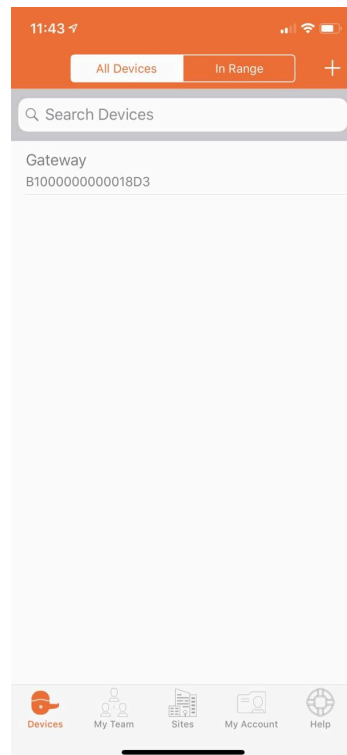

Figure 6.11

NDE Lock Commissioning

Similar to the Gateway, the NDE lock commissioning is done using the ENGAGE mobile App and a Bluetooth connection, so Bluetooth needs to be enabled on the phone and lock, and you must be within Bluetooth range (same room). The commissioning process is unique to each lock, so it'll have to be done for every lock added to the site.

To commission an NDE lock, do as follows:

- Starting from the devices screen (Figure 7.1), press the plus (+) sign in the top right corner. This will show a new screen with different types of devices (Figure 7.2).
- Select the NDE lock. This will show you a new screen that will ask you to “Turn and release the interior lever”(Figure 7.3).
- Turn and release the interior level. You should hear a single beep. Press next on the application screen. This will show a new screen where it will scan for nearby locks (Figure 7.4).
- If the NDE lock is shown, select it. If not, try moving closer to the lock, and restart the process. If the process fails again, perform an NDE Lock Factory Default reset (as described in the hardware installation guide), and start over.
- Once the NDE lock is selected, please verify that the LED is blinking as indicated in the Application (Figure 7.5). If it is, press Yes.
- After this, you'll be asked to select a name for the lock. We recommend setting a name that will differentiate it from other locks that might be installed on the site (Figure 7.6).
- For wireless locks with a small lock button on the inside lever, you will be presented with some configuration options (Figure 7.10). Select the one that fits your needs, but if you are not sure we recommend “office”.
- Afterwards, you'll be asked to select the Wi-Fi network (Figure 7.8). Select either a saved one or click on one in the list of Wi-Fi networks and enter the password (Figure 7.9). Alternatively, if the gateway you intend to link to the wireless lock is already connected to the internet, you can just press “skip”.
- After this you'll be shown a screen indicating the application is “preparing your device” (Figure 7.11).
- After the process is completed you'll be shown a screen indicating success with a green checkmark. Press the Finish button (Figure 7.12).
- Finally you'll be redirected to the devices screen, and the new lock should be shown in the list of devices linked to that site (Figure 7.13).

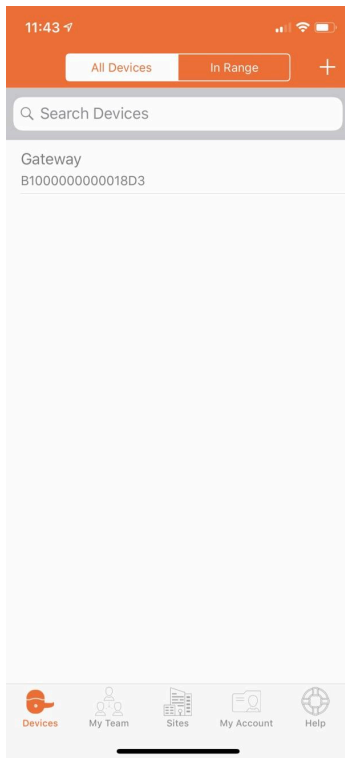

Figure 7.1

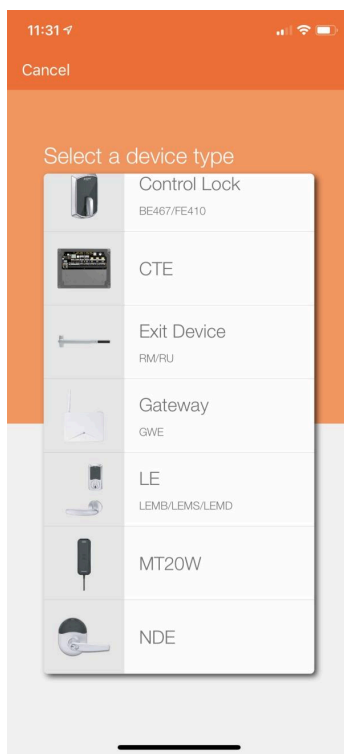

Figure 7.2

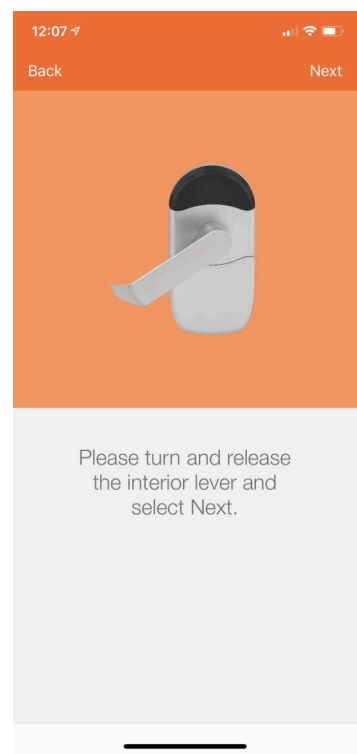

Figure 7.3

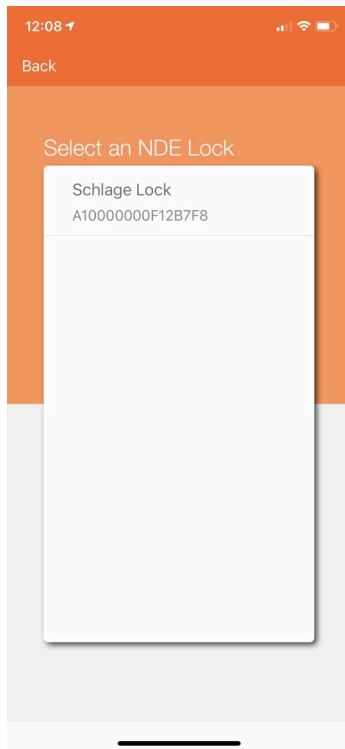

Figure 7.4

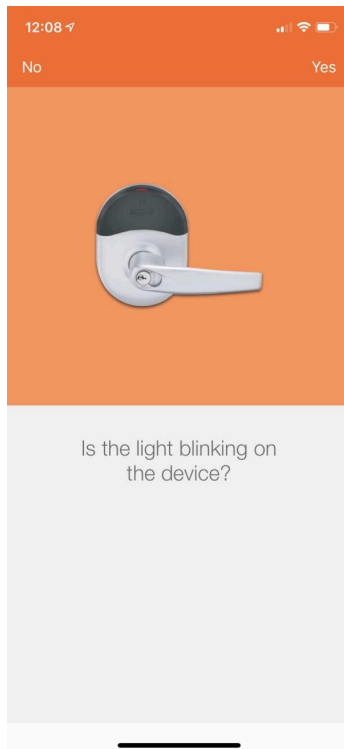

Figure 7.5

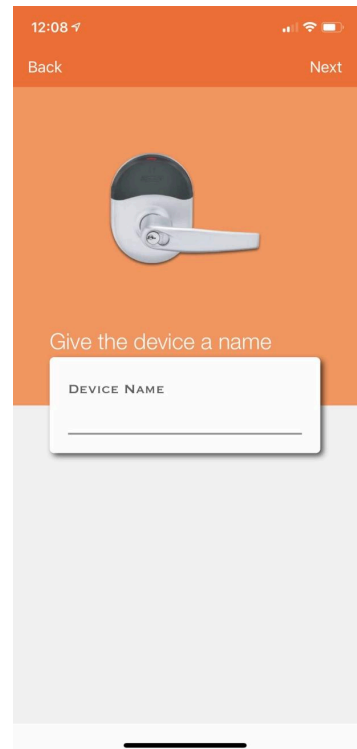

Figure 7.6

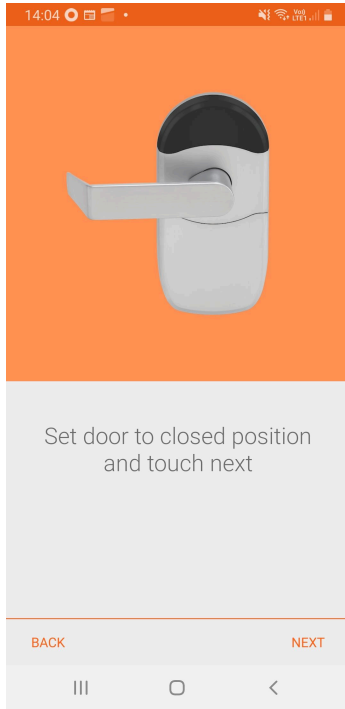

Figure 7.7

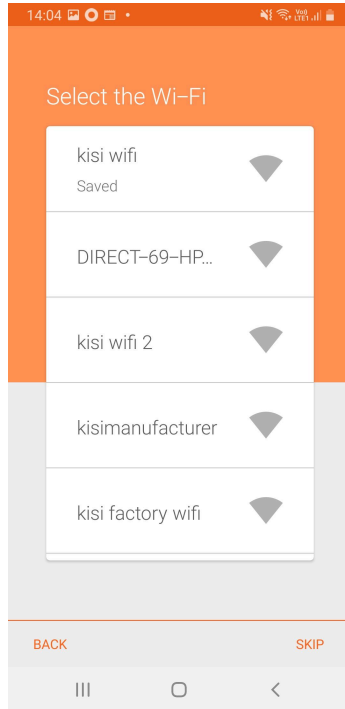

Figure 7.8

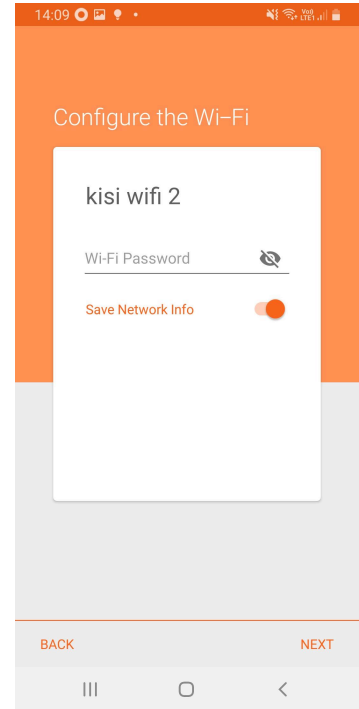

Figure 7.9

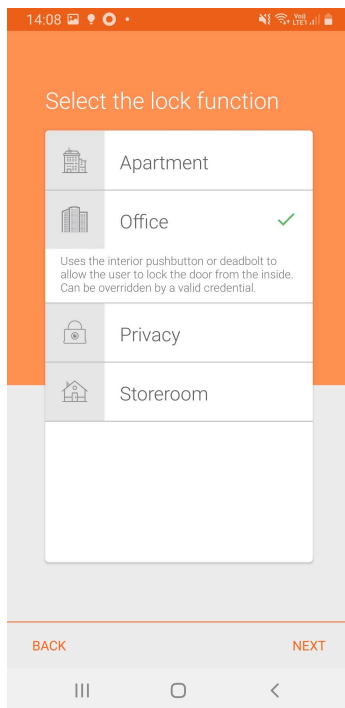

Figure 7.10

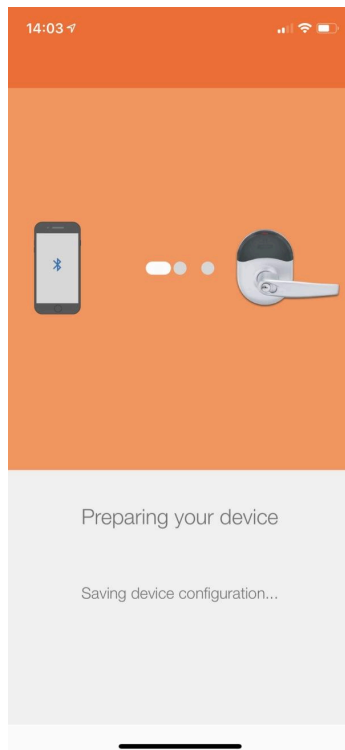

Figure 7.11

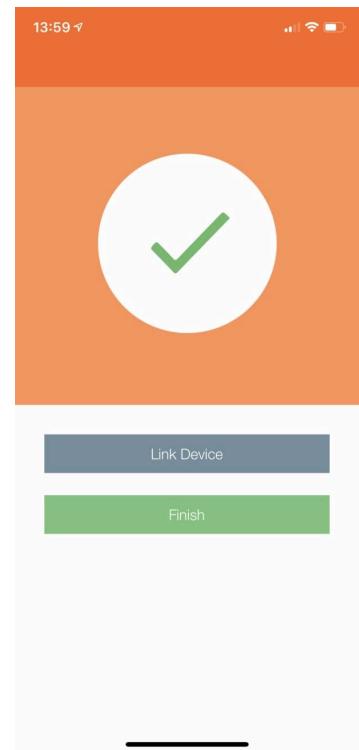

Figure 7.12

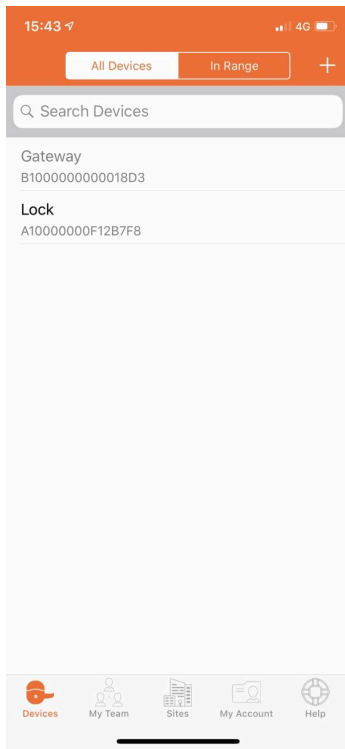

Figure 7.13

This step is only valid if the NDE lock was installed with the contact sensor magnets on the frame. This is highly recommended.

In order to properly detect the opening and closing of the door, it is necessary to calibrate the contact sensor of the lock. This calibration process is unique to each lock, so it'll have to be done for every lock added to the site.

Start by closing the door of the lock to calibrate, then do the following:

- Open the ENGAGE app and go to the devices page (Figure 8.1)
- In the list of linked devices, if the lock name is shown with dark letters (Figure 8.1), select the lock
- If the lock name is shown in light letters (Figure 8.2), pull the list down to refresh (8.3). Do this until the lock name is shown in dark letters (this usually happens when the lock hasn't established a network connection yet).
- When you select the lock, you'll be shown a new screen, and a "connecting to device" message (Figure 8.4). Wait for the App to show you the "connected" state in the bottom of the screen (Figure 8.5).
- To verify that you're connected to the right lock, check that its LED is blinking red.
- Once connected, press the "Settings" button. After this you'll be shown the settings screen (Figure 8.6)
- In the section "General" of the Settings screen, press the "Calibrate Door Position" button. This will show a message (Figure 8.7). Press calibrate.
- After this you'll be shown a success message at the bottom of the screen (8.8).
- Press the "Save" button located in the top right corner. If successful you'll be shown a message at the bottom of the screen (8.9)
- Return to Devices screen by pressing two times on the back button in the top left corner.
- After the process is completed you'll be shown a screen indicating success with a green checkmark. Press the exit button (Figure 8.10).

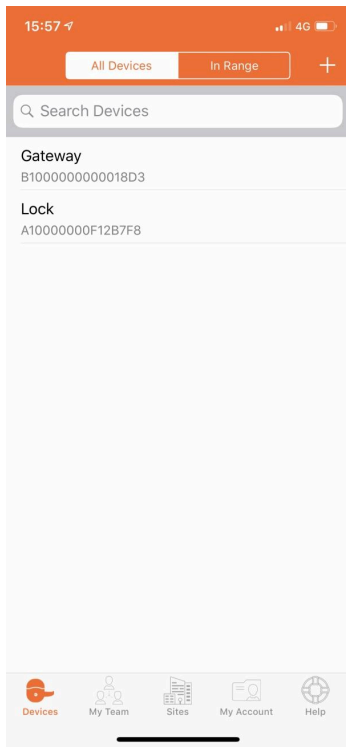

Figure 8.1

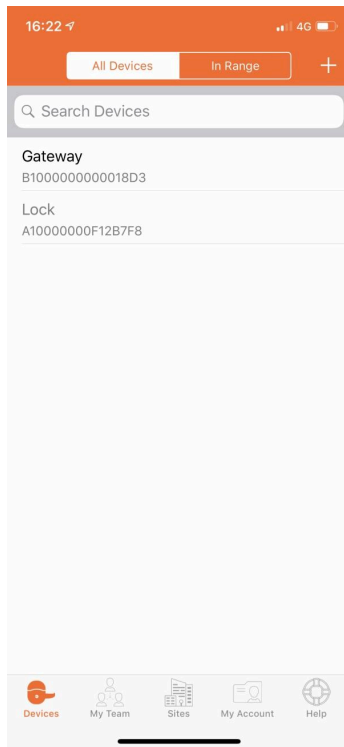

Figure 8.2

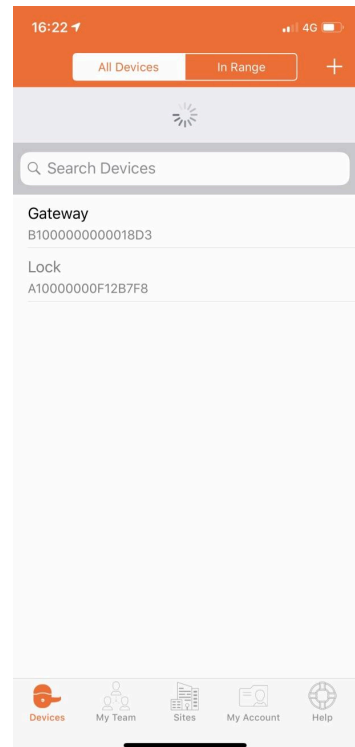

Figure 8.3

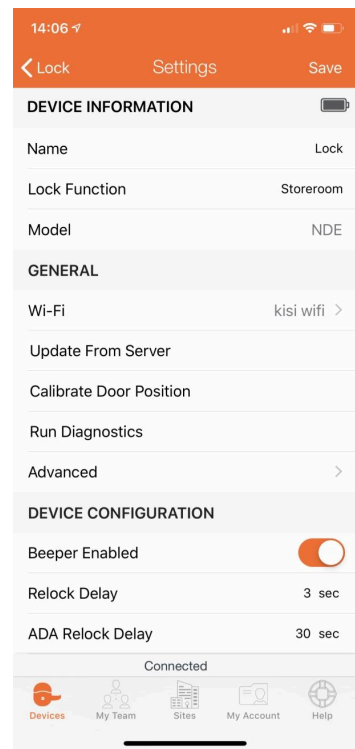
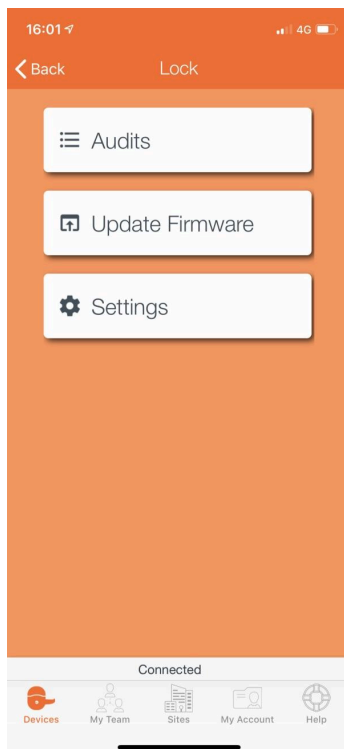
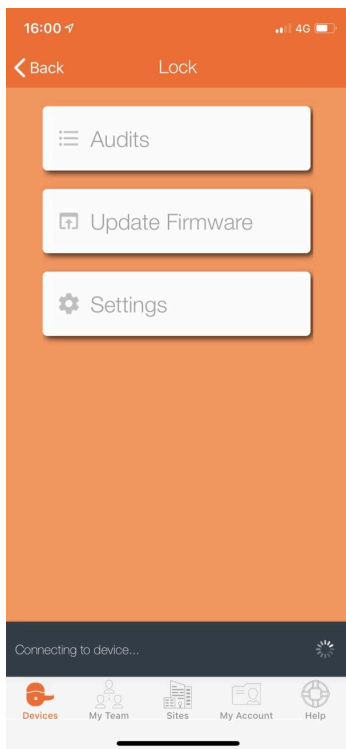

Figure 8.4

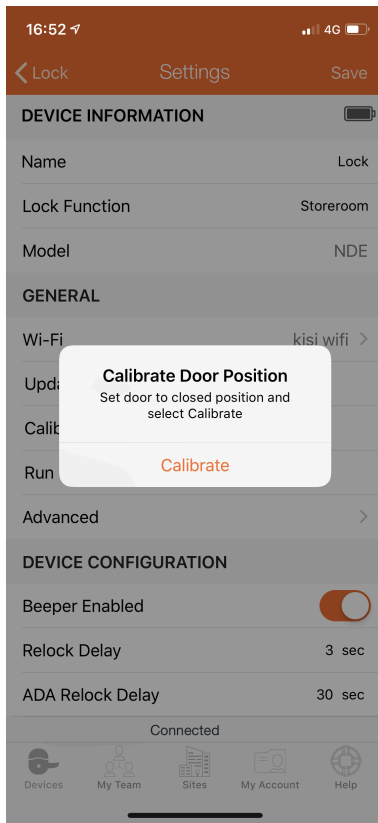

Figure 8.7

Figure 8.5

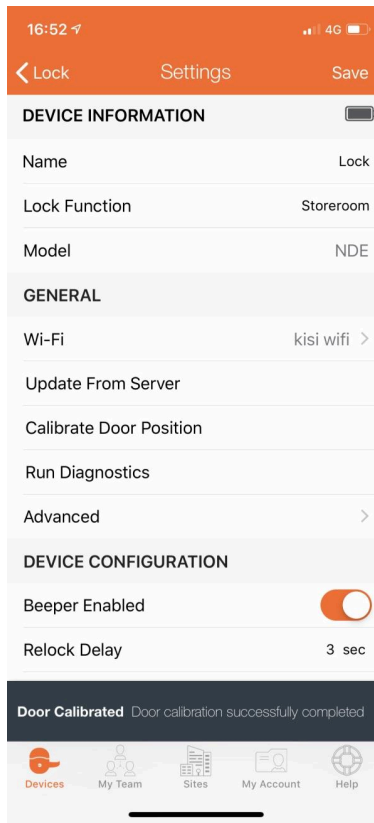

Figure 8.8

Figure 8.6

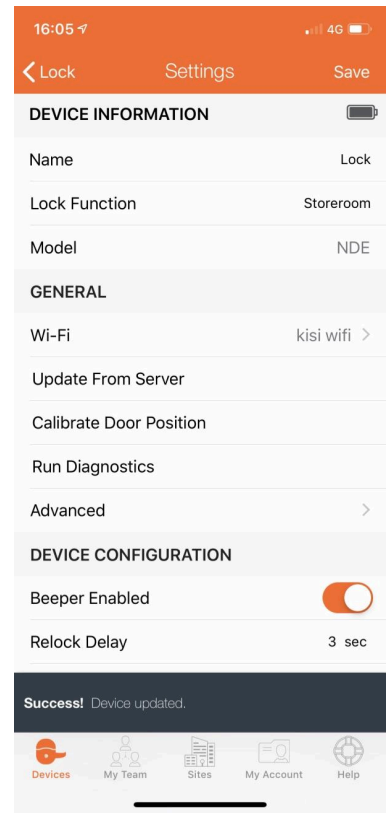

Figure 8.9

LE Lock Commissioning

Similar to the Gateway and NDE lock, the LE lock commissioning is done using the ENGAGE mobile App and a Bluetooth connection, so Bluetooth needs to be enabled on the phone and lock, and you must be within Bluetooth range (same room). The commissioning process is unique to each lock, so it'll have to be done for every lock added to the site.

To commission a LE lock, do as follows:

- Starting from the device's screen, press the plus (+) sign in the top right corner. This will show a new screen with different types of devices.
- Select the LE lock. This will show you a new screen that will ask you to “Turn and release the interior lever”.
- Turn and release the interior level. You should hear a single beep. Press next on the application screen. This will show a new screen where it will scan for nearby locks.
- If the LE lock is shown, select it. If not, try moving closer to the lock, and restart the process. If the process fails again, perform an LE Lock Factory Default reset (as described in the hardware installation guide), and start over.
- Once the LE lock is selected, please verify that the LED is blinking as indicated in the Application. If it is, press Yes.
- After this, you'll be asked to select a name for the lock. We recommend setting a name that will differentiate it from other locks that might be installed on the site .
- For wireless locks with a small lock button on the inside lever, you will be presented with some configuration options. Select the one that fits your needs, but if you are not sure we recommend “office”.
- Afterwards, you'll be asked to select the Wi-Fi network. Select one from the list of Wi-Fi networks and enter the password. Alternatively, if the gateway you intend to link to the wireless lock is already connected to the internet, you can just press “skip”.
- After this you'll be shown a screen indicating the application is “preparing your device”.
- After the process is completed you'll be shown a screen indicating success with a green checkmark. Press the Finish button.
- Finally you'll be redirected to the devices screen, and the new lock should be shown in the list of devices linked to that site.

The application screenshots have been omitted for brevity, since the process is identical to the commissioning process for the NDE lock, and you can refer to figures 7.1 to 7.13 in the [NDE lock commissioning section](#) for the graphical flow.

Gateway - Lock Link

Now that the Gateway and one or more Locks are commissioned to the site, we need to link the locks to the gateway. Before we proceed, it's important to make some remarks:

- Each Lock can be linked to a single Gateway.
- A gateway can have up to ten linked NDE/LE Locks.
- The linking process is individual of each.
- The linking process is unique to each lock, so it'll have to be done for every lock you want to link to the gateway.
- To properly link a Lock to the Gateway, the Lock need to be within the range of the gateway, so be aware of the limitations. For more information, check the Hardware Installation Guide.

The linking process is done using the ENGAGE mobile App and a Bluetooth connection, so Bluetooth needs to be enabled on the phone and you must be aware of the distance between phone and gateway when linking it to a lock.

To link the do the following:

- Open the ENGAGE app and go to the devices page (Figure 9.1)
- In the list of linked devices, if the gateway name is shown in dark letters (Figure 9.1), select it.
- If the gateway name is shown in light letters (Figure 9.2), pull the list down to refresh (9.3). Do this until the gateway name is shown in dark letters. If it is not shown in dark letters, please stand closer to the gateway, and be sure that it is powered on.
- When you select the gateway, you'll be shown a new screen, and a "connecting to device" message (Figure 9.4). Wait for the App to show you the "connected" state in the bottom of the screen (Figure 9.5).
- Press the "Linked Devices Button". This will send you to a new screen that will try to retrieve the locks linked to that gateway (Figure 9.6). If this is the first time you link a lock, no locks will be shown.
- To link a new lock, press on the plus (+) button on the top right corner of the screen. This will send you to a new screen that shows different types of devices (Figure 9.7). Select the NDE/LE.
- After this, a new screen will show up. Here we'll need to assign a door number (Figure 9.8). The number itself is not inherently important, but be aware that **each lock has a unique number from 0 to 9**. It's important to remember which you picked, for the process of connecting to the Kisi interface. After selecting the door number press next.

- In this next screen you're explained how to set the desired lock in Link Mode (Figure 9.9). To do so, do the following:
 - Hold down the interior lever
 - With the lever held down, present a credential. This credential will have been included with your locks (Figure 9.10)
 - When the indication LED starts blinking red and green, release the lever.
 After doing this, press next on the screen.
- The gateway and lock should now be linking, and you'll be shown this correspondingly in the mobile app (Figure 9.11)
- After the process is completed you'll be shown a screen indicating success with a green checkmark. Press the exit button (Figure 9.12).
- After this you'll be redirected to the list of linked locks of the gateway, where the new lock should be. (Figure 9.13) You can keep adding locks from this point on, or exit once you're finished.
- Note: If the gateway's status LED is stuck blinking blue, you may need to power cycle the gateway to resume normal operation.

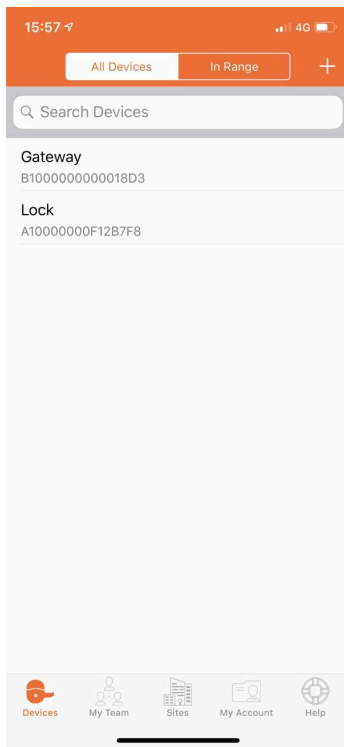

Figure 9.1

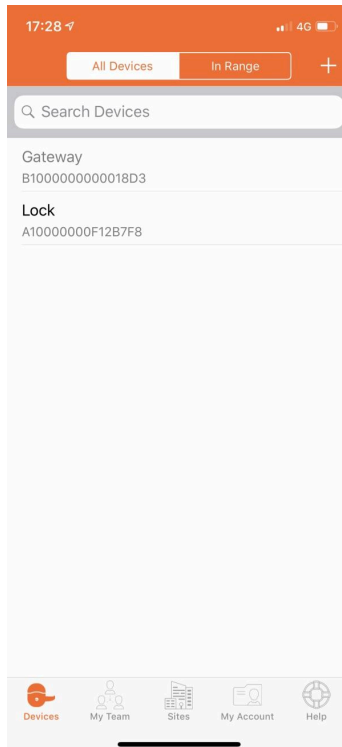

Figure 9.2

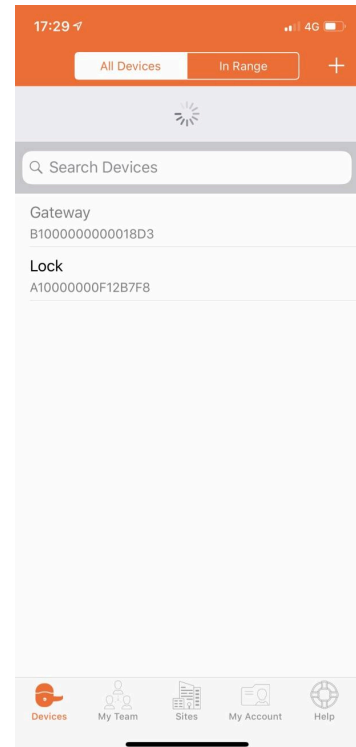

Figure 9.3

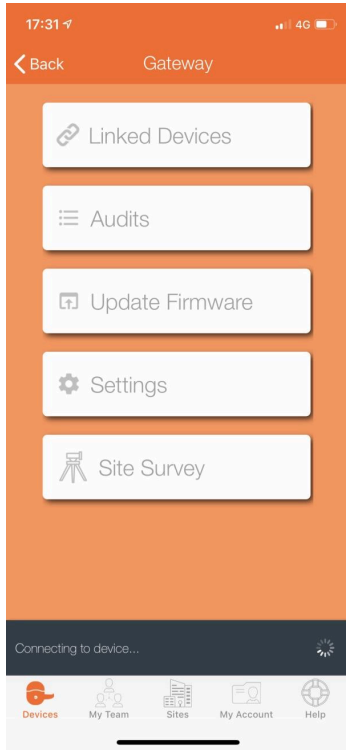

Figure 9.4

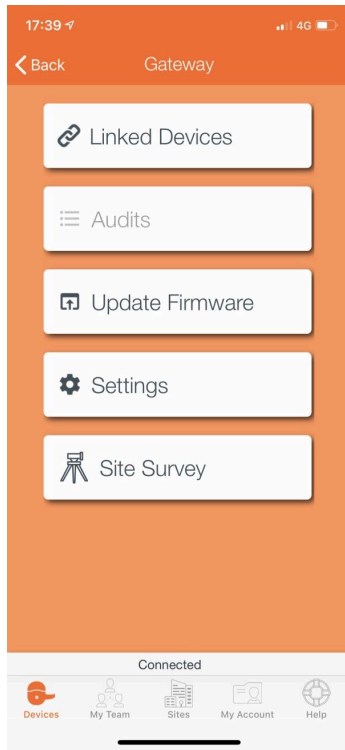

Figure 9.5

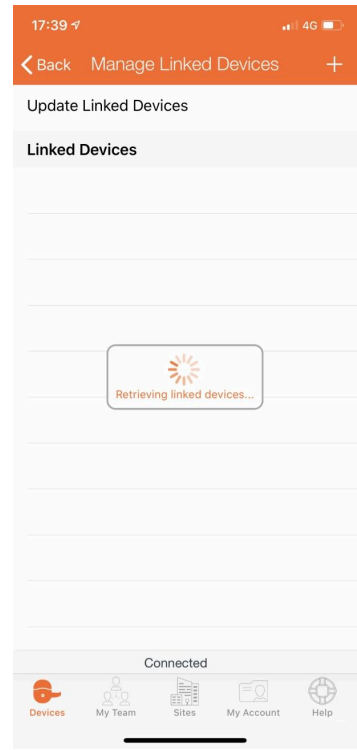

Figure 9.6

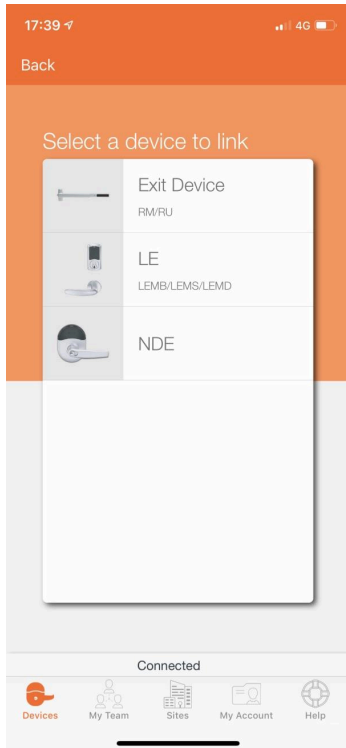

Figure 9.7

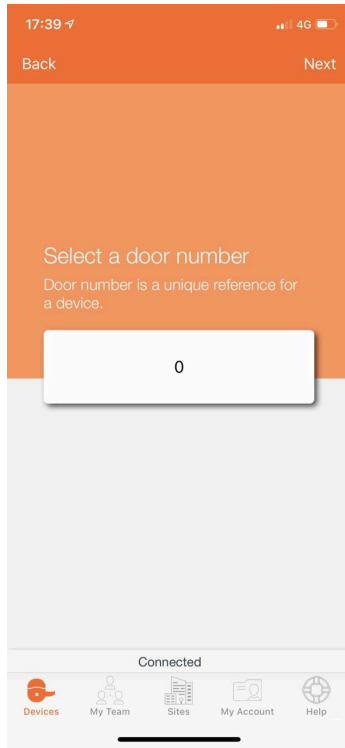

Figure 9.8

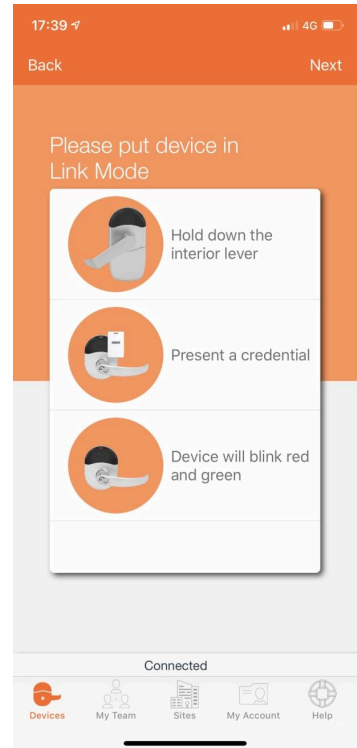

Figure 9.9

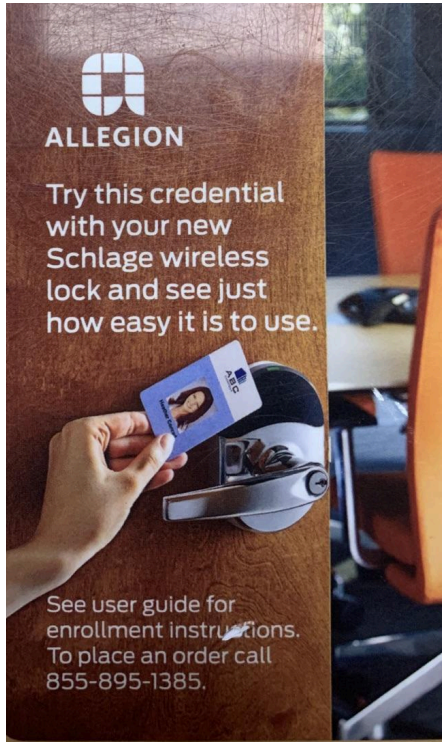

Figure 9.10

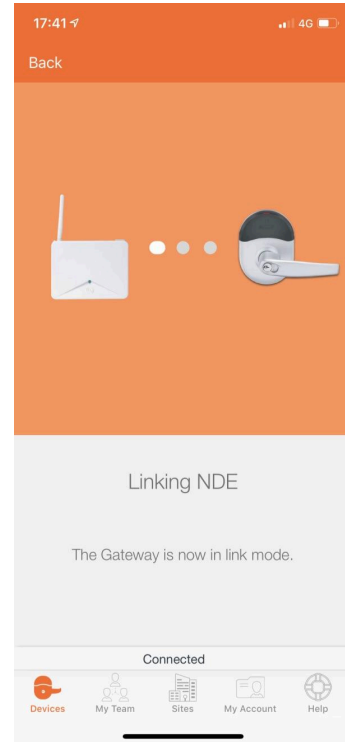

Figure 9.11

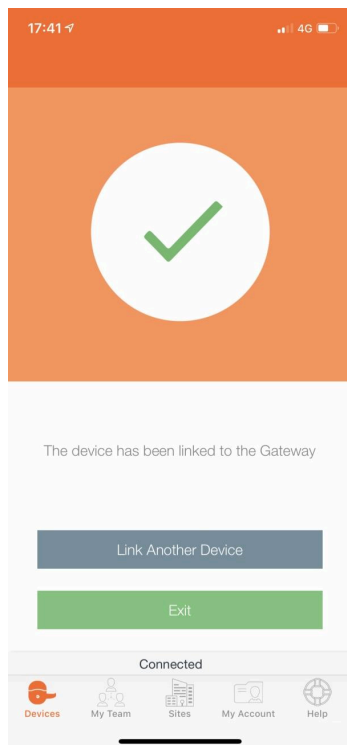

Figure 9.12

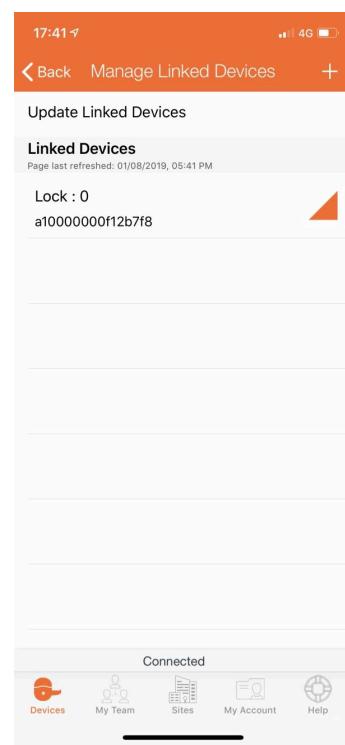

Figure 9.13

Gateway - Status

The gateway has a status LED which indicates what state the gateway is currently in. The list is provided below for your reference, but can also be found [here](#).

Status LED	Meaning	Type of LED User Interface
Solid amber	Gateway is booting up	State
Long flash amber, repeating	Gateway Wi-Fi access point is active	State
Fast flash x2, repeating for 1 minute	Factory default reset did not complete successfully	Status code
Fast flash x3, repeating for 1 minute	Power on self test failure	Status code
Solid blue	Gateway is commissioned, normal operation	State
Long flashing blue	Mobile application is connected to Gateway	State
Fast flash blue, repeating	Gateway is in link mode - connected and linking to new lock	State
Alternating long flashing blue and red	Gateway is in link mode - searching for new lock	State
Solid red	Factory Default State / Uncommissioned	State
Fast flash red x4	Linking to lock was not a success	Status code
Alternating green and red long flashes, repeat	Gateway is updating its firmware	State
Solid green	Gateway is in process of resetting to default settings	State
Fast flash green x2	Gateway will begin a factory default reset	Response to user action
Fast flash green x3	Linking to lock was a success FW upgrade succeeded	Status code

